



## EXCLUSIVE LIFT INDICATORS

-  Real Glass
-  Non-flammable
-  Exchangeable illuminat

 **UNIQUE**



## Contents

pages

5

Lift Identifier - Mirror Glass

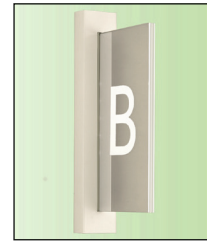

6

Lift Identifier - Black

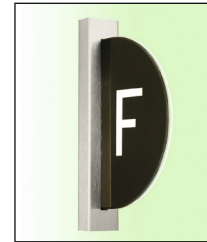

7

Lift Identifier - Transparent



8

Lift Identifier - Transparent

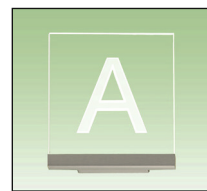
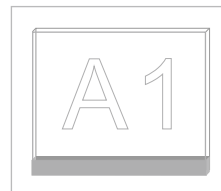

9

Direction Arrows / Blade Hall Lantern

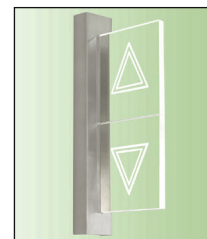

10

Direction Arrows / Blade Hall Lantern

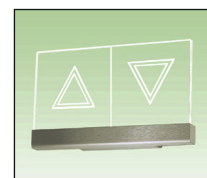

11 - 14

Technical Data

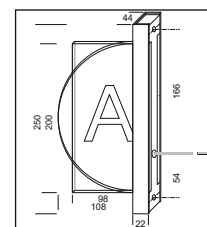

15 - 18

NOTES / General Information / Imprint



## GlassLine Lift Identifier 90 Degrees - Mirrow Glass

Exclusive indicator series consisting of two laminated mirror glass panes with light separating foil and engraved characters on both insides illuminated with high-efficiency LEDs of the latest technology.

Light colours:



All indicators have a white standby light with only 1.2W and a second light colour of your choice. Hereby, the reflecting surface of the character is illuminated. Together with the discreetly shining glass edge the indicator ensures an appealing contrast to the surroundings.

Optionally, the selected coloured light can also be used as standby light or to indicate the arrival / standby position of the lift in a stop. For lifts with destination control, the coloured light can be used to indicate the allocated lift. When the coloured light is turned on, the white light switched off automatically during this operation time.



 optional with integrated Gong



Alternative: incorporated in flush mount fixture

### Model Variants



GL120v-L-90-Mirror  
46 x 250 mm



GL120v-L-90-Mirror-X40  
Front plate, stainless steel:  
100 x 310 mm with wall box or  
100 (90) x 310 mm with box for  
panel fixing



GL128hrv-L-90-Mirror  
46 x 250 mm



GL128hrv-L-90-Mirror-X40  
Front plate, stainless steel:  
100 x 310 mm with wall box or  
100 (90) x 310 mm with box for  
panel fixing

### Features

- Laminated glass with high scratch-resistance
- Exchangeable illuminant
- Surface mount or flush mount
- Non-flammable

Norm compliance

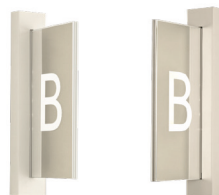

right view

left view



Facing:

- stainless steel fine brushed
- optional white

## GlassLine Lift Identifier 90 Degrees - Black

Exclusive indicator series consisting of two laminated black toned glass panes with engraved characters on both insides illuminated with high-efficiency LEDs of the latest technology.

Light colours:



White



Emerald green

All indicators have a white standby light with only 1.2W and a second green light colour. Hereby, the reflecting surface of the character is illuminated. Together with the discreetly shining glass edge the indicator ensures an appealing contrast to the surroundings. Optionally, the selected coloured light can also be used as standby light or to indicate the arrival / standby position of the lift in a stop. For lifts with destination control, the coloured light can be used to indicate the allocated lift. When the coloured light is turned on, the white light switched off automatically during this operation time.



 optional with integrated Gong



Alternative: incorporated in flush mount fixture

### Model Variants



GL128hrv-L-90-Black  
46 x 250 mm



GL128hrv-L-90-Black-X40  
Front plate, stainless steel:  
100 x 310 mm with wall box or  
100 (90) x 310 mm with box for  
panel fixing

### Features

- **Laminated glass with high scratch-resistance**
- **Exchangeable illuminant**
- **Surface mount or flush mount**
- **Non-flammable**

Norm compliance

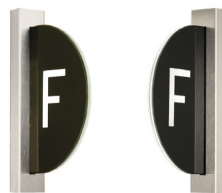

right view

left view



Facing:

- stainless steel fine brushed
- optional white

## GlassLine Lift Identifier 90 Degrees - Transparent

Exclusive indicators consisting of premium glass with characters illuminated by highly efficient LEDs of the latest technology. The panes are fitted in a fine brushed stainless steel bracket.

Light colours:



White



Emerald green

All indicators have a white standby light with only 1.2W and a second green light colour. Hereby, the reflecting surface of the character is illuminated. Together with the discreetly shining glass edge the indicator ensures an appealing contrast to the surroundings. Optionally, the selected coloured light can also be used as standby light or to indicate the arrival / standby position of the lift in a stop. For lifts with destination control, the coloured light can be used to indicate the allocated lift. When the coloured light is turned on, the white light switched off automatically during this operation time.



Example with activated white LED light

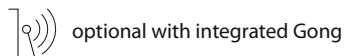

### Features

- Premium glass with high scratch-resistance
- Exchangeable illuminant
- Surface mount or flush mount
- Non-flammable

Norm compliance



### Model Variants



GL120v-L-90  
46 x 250 mm



GL120v-L-90-X40  
Front plate, stainless steel:  
100 x 310 mm with wall box or  
100 (90) x 310 mm with box for  
panel fixing



GL128hrv-L-90  
46 x 250 mm



GL128hrv-L-90-X40  
Front plate, stainless steel:  
100 x 310 mm with wall box or  
100 (90) x 310 mm with box for  
panel fixing









Facing:

- stainless steel  
fine brushed
- optional white

## GlassLine Lift Identifier - Transparent

Exclusive indicators consisting of premium glass with characters that are illuminated by highly efficient LEDs of the latest technology. The panes are fitted in a fine brushed stainless steel bracket.

Light colours:

GL160h-L					
GL160h-2L	White	Emerald green	Red	Amber	Blue
GL200h-L (transparent)					
	White	Emerald green			

All indicators have a white standby light with only 1.2W/character and a second light colour of your choice. Hereby, the reflecting surface of the character is illuminated. Together with the discreetly shining glass edge the indicator ensures an appealing contrast to the surroundings.

Optionally, the selected coloured light can also be used as standby light or to indicate the arrival / standby position of the lift in a stop. For lifts with destination control, the coloured light can be used to indicate the allocated lift. When the coloured light is turned on, the white light switched off automatically during this operation time.

### Features

- Premium glass with high scratch-resistant on the front
- Exchangeable illuminant
- Surface mount
- Non-flammable



optional with Gong  
The gong speaker is invisibly integrated in the wall holder.



Example with activated white LED light

Norm compliance

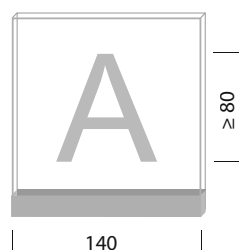

GL160h-L

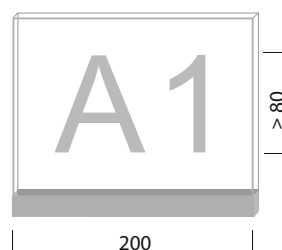

GL160h-2L

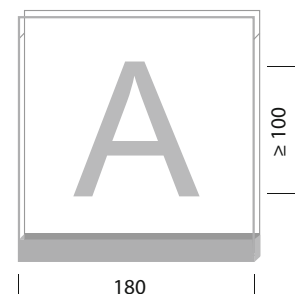

GL200h-L



## GlassLine Direction Arrows / Blade Hall Lantern 90°

Exclusive indicators consisting of premium glass with engraved arrows that are illuminated by highly efficient LEDs of the latest technology.

Light colours:



All indicators have a white LED light with only 1.2W and a second light colour of your choice.

Operating modes:

Arrows up and down with white light

Arrows up and down with coloured light

Arrows up and down with coloured light and white standby light

If the direction arrow is indicated with coloured LED light, the white LED light can optionally be switched on in standby mode. The white backlight spreads a pleasant, discreet orientation light in the entrance halls and building floors. When the coloured light of an arrow is turned on, the white light of this arrow switched off automatically during this operation time.

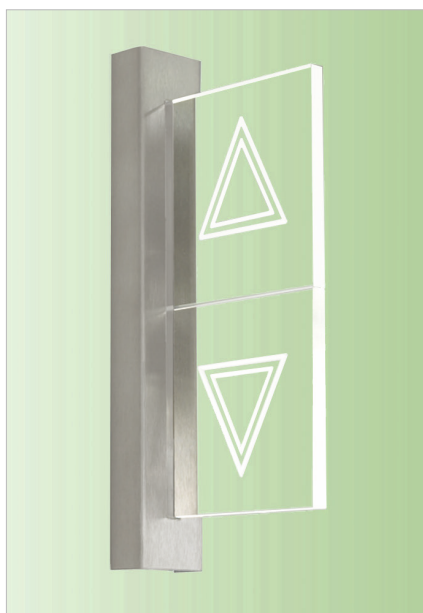

Example with activated white LED light



optional with Gong

The gong speaker is invisibly integrated in the wall holder.

### Features

- Premium glass with high scratch-resistance
- Exchangeable illuminant
- Surface mount or flush mount
- Non-flammable

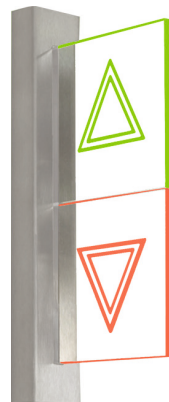

Example with activated LED light green + red

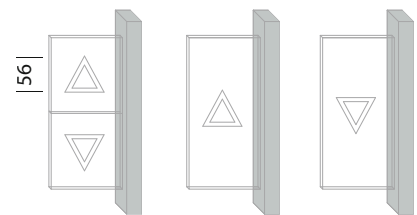

GlassLine GL120v-P-90  
46 x 250 mm

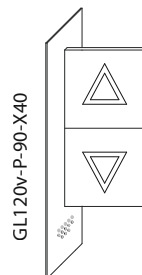

Optional: flush mount  
with finely ground stainless steel front plate:  
100 x 310 mm with wall box or  
100 (90) x 310 mm with box for panel fixing



Facing:

- stainless steel fine brushed
- optional white

Norm compliance



## GlassLine Direction Arrows / Blade Hall Lantern, horizontal

Exclusive indicators are made from premium glass with arrows that are illuminated by highly efficient LEDs of the latest technology. The panes are fitted in a fine brushed stainless steel bracket.

Light colours:



All indicators have a white LED light with only 1.2W and a second light colour of your choice.

Operating modes:

Arrows up and down with white light

Arrows up and down with coloured light

Arrows up and down with coloured light and white standby light

If the direction arrow is indicated with coloured LED light, the white LED light can optionally be switched on in standby mode. The white backlight spreads a pleasant, discreet orientation light in the entrance halls and building floors. When the coloured light of an arrow is turned on, the white light of this arrow switched off automatically during this operation time.

### Features

- Premium glass with high scratch-resistance on the front
- Exchangeable illuminant
- Surface mount or flush mount
- Non-flammable



optional with Gong

The gong speaker is invisibly integrated in the wall holder.

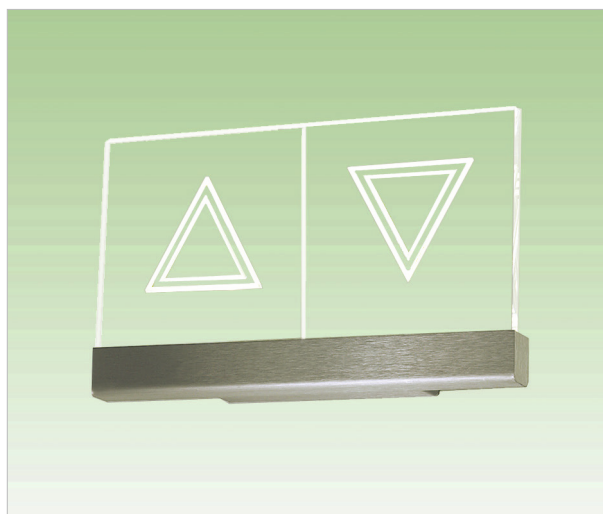

Example with activated white LED light

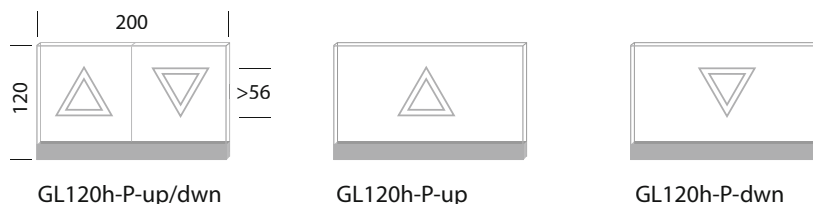

Norm compliance



# GlassLine Technical data

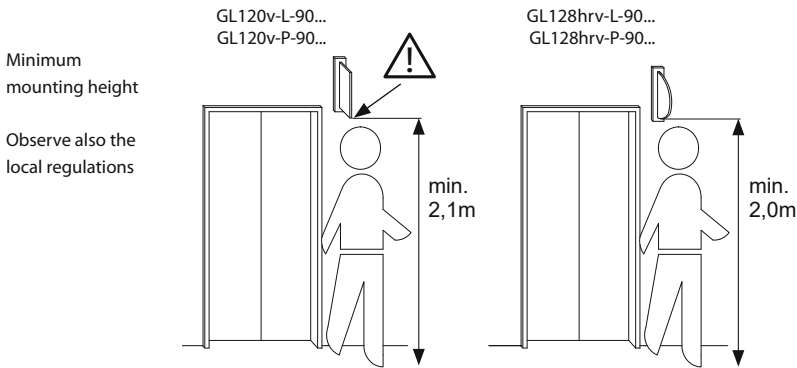

Supply voltage: 20-28V DC  
 Current: ≤ 50mA / arrow or character  
 (Amber ≤ 58mA/arrow or character)  
 Power: 1.2W (1.4W Amber)/arrow o. character at 24V  
 Control: common anode or cathode  
 Protection class: IP20

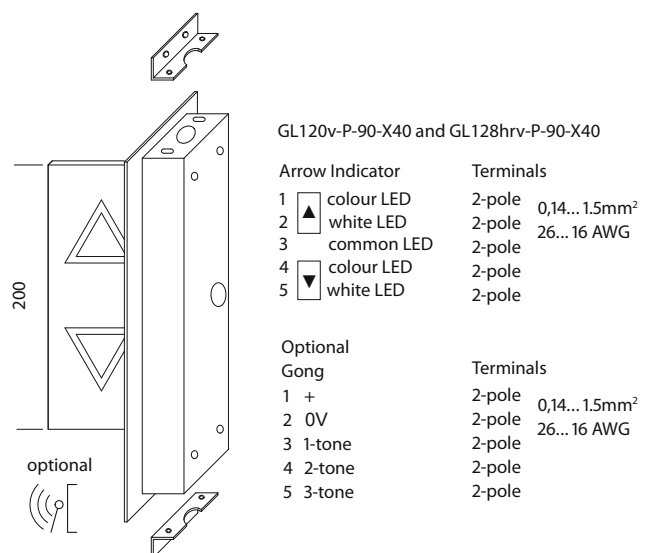
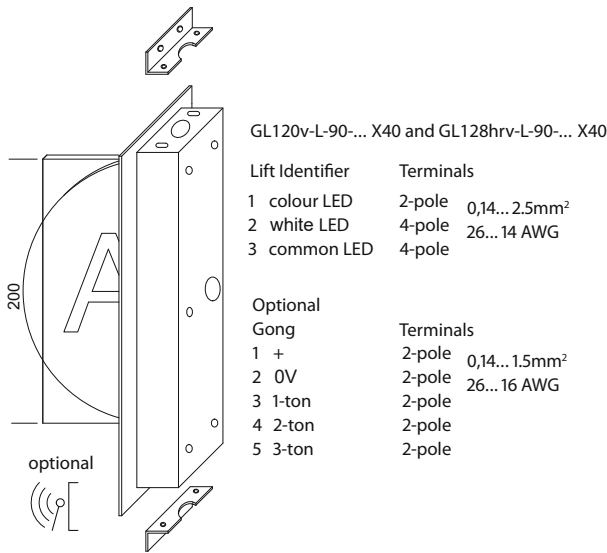

Function table ● = Signal on

Input colour LED	Input white LED	Function	Operation Current ≤ 50mA/character or arrow (Amber LEDs ≤ 58mA)
		LEDs off	—
	●	white LEDs on (optional usable as background light)	via input „white LED“
●		colour LEDs on	via input „colour LED“
●	●	colour LEDs on, white LED off	current flows only via input „colour LED“

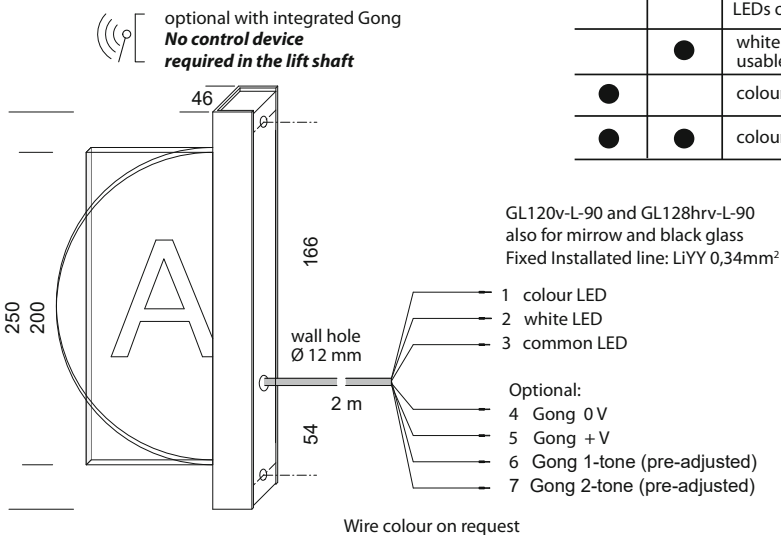

Fixing parts for concrete walls and sheet panels included in the delivery.  
 Required pre-drilling:  
 in 1.5mm sheet panel: Ø 4.0 mm  
 in 2.0mm sheet panel: Ø 4.2 mm

Prozessorgong PG37

Tone variants to EN81-70: 1-tone  
 2-tone  
 3-tone

Control: common anode or cathode adjustable

Volume: adjustable

Tone pitch: adjustable

Voltage: 12-30V DC

Standby and signal currents: 10 mA

Operating current (peak): < 200 mA

Sound pressure: ≥ 65 dB(A)

Temperature range: -10° C - +65C°

Also suitable as a two-wire installation

Further information see chapter Accoustic

# GlassLine Technical data

Minimum mounting height  
Observe also the local regulations

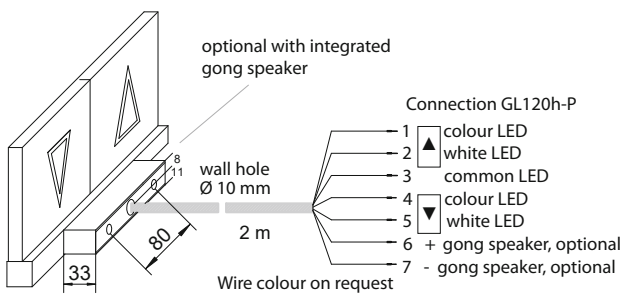
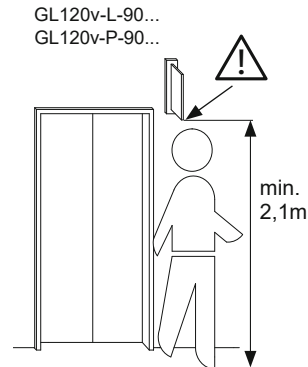

- Connection GL120h-P
- 1 ▲ colour LED
  - 2 ▲ white LED
  - 3 common LED
  - 4 ▼ colour LED
  - 5 ▼ white LED
  - 6 + gong speaker, optional
  - 7 - gong speaker, optional

Fixing parts for concrete walls and sheet panels included in the delivery.  
Required pre-drilling:  
in 1.5mm sheet panel: Ø 4.0 mm  
in 2.0mm sheet panel: Ø 4.2 mm

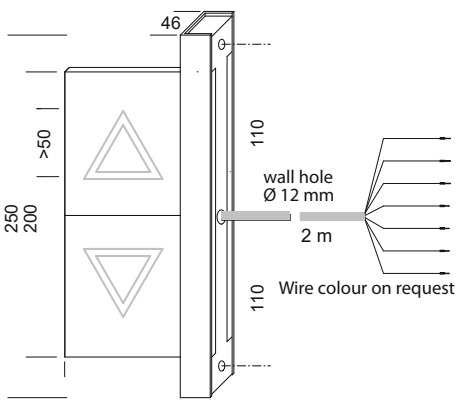

- Connection GL120v-P-90-up+down
- 1 ▲ colour LED
  - 2 ▲ white LED
  - 3 common LED
  - 4 ▼ colour LED
  - 5 ▼ white LED
  - 6 + gong speaker, optional
  - 7 - gong speaker, optional

Fixing parts for concrete walls and sheet panels included in the delivery.  
Required pre-drilling:  
in 1.5mm sheet panel: Ø 4.0 mm  
in 2.0mm sheet panel: Ø 4.2 mm

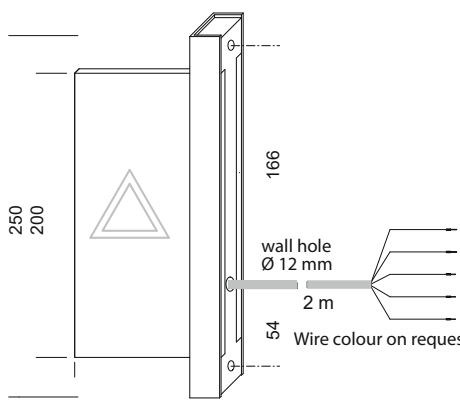

- Connection GL120v-P-90-up  
GL120v-P-90-down
- 1 ▲ colour LED
  - 2 ▲ white LED
  - 3 common LED
  - 4 + gong speaker, optional
  - 5 - gong speaker, optional

Fixing parts for concrete walls and sheet panels included in the delivery.  
Required pre-drilling:  
in 1.5mm sheet panel: Ø 4.0 mm  
in 2.0mm sheet panel: Ø 4.2 mm

Supply voltage: 20-28V DC  
Current: ≤ 50mA / arrow (Amber ≤ 58mA/arrow)  
Power: 1.2W (1.4W Amber)/ arrow at 24V  
Control: common anode or cathode  
Fixed installed line on the indicators: LIYY 5/7 x 0,34mm<sup>2</sup>  
Protection class: IP20

Function table ● = Signal on

Input colour LED	Input white LED	
		LEDs off
	●	white LEDs on (optional usable as background light)
●		colour LEDs on
●	●	colour LEDs on, white LED off. operating current via input of the colour LED



Optional

Control device in lift shaft required for specification with gong

Protection class: IP20

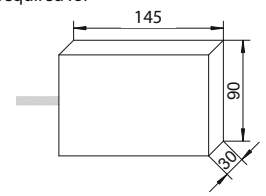

Terminal in the control device

LED Control	Gong PG37	
0,14 ... 1.5mm <sup>2</sup>	0,14... 0.5mm <sup>2</sup>	0V
26... 16 AWG	26... 20 AWG	1-ton
		2-ton
		3-ton

Tone variants to EN81-70:

- 1-tone
- 2-tone
- 3-tone

Control: common anode or cathode

- Volume: adjustable
- Tone pitch: adjustable
- Voltage: 12-30V DC
- Standby and signal currents: 10 mA
- Operating current (peak): < 200 mA
- Sound pressure: ≥ 65 dB(A)
- 80 dB (A) on request
- Temperature range: -10° C - +65C°

Also suitable as a two-wire installation

Further information see chapter Accoustic

## GlassLine Technical data

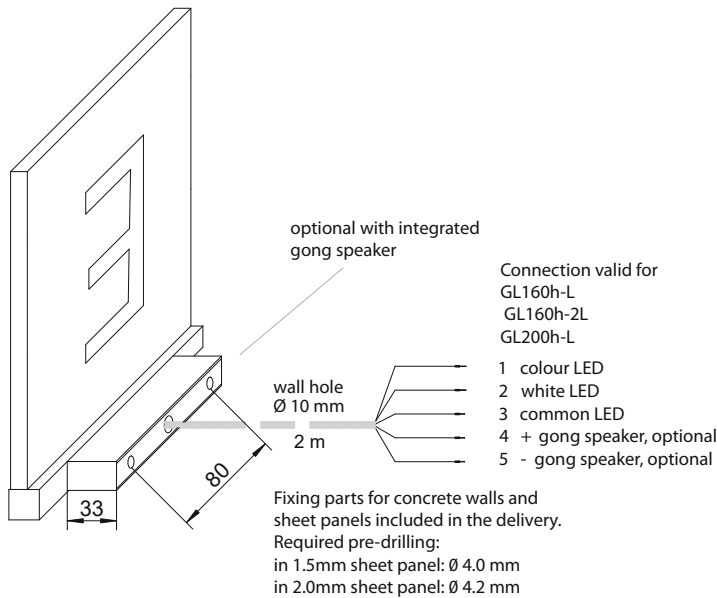

Supply voltage: 20-28V DC  
Current: ≤ 50mA / character (Amber ≤ 58mA/character)  
Power: 1,2W (1.4W Amber)/character at 24V  
Control: common anode or cathode  
Fixed installed line on the indicators: LIYY 3/5 x 0,34mm<sup>2</sup>  
Protection class: IP20



### Optional

Control device in lift shaft required for specification with gong

Protection class:  
IP20

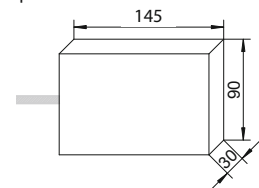

Terminal in the control device

LED Control	Gong PG37
0,14 ... 1.5mm <sup>2</sup>	0,14...0.5mm <sup>2</sup>
26... 16 AWG	26... 20 AWG

Function table ● = Signal on

Input colour LED	Input white LED	Function	Operation Current ≤ 50mA/character (Amber LEDs ≤ 58mA)
		LEDs off	—
	●	white LEDs on (optional usable as background light)	via input „white LED“
●		colour LEDs on	via input „colour LED“
●	●	colour LEDs on, white LED off	current flows only via input „colour LED“

Tone variants to EN81-70: 1-tone  
2-tone  
3-tone

Control: common anode  
or cathode

Volume: adjustable  
Tone pitch: adjustable  
Voltage: 12-30V DC  
Standby and signal currents: 10 mA  
Operating current (peak): < 200 mA  
Sound pressure: ≥ 65 dB(A)  
80 dB (A) on request

Temperature range: -10° C - +65C°

Also suitable as a two-wire installation  
Further information see chapter Accustic

# GlassLine Technical Data

GL120v-L-90 ... X40  
 GL120v-P-90 ... X40  
 GL128hrv-L-90 ... X40

Specification with back box

Faceplate material	stainless steel, fine brushed, 2 mm option: other materials
Back box material	galvanised sheet metal 1.5mm accessory: adjustable angle brackets
Fittings fixing	back box fixing
Faceplate fixing	concealed screws
Fixture mounting	plastered into wall cutout or via adjustable angle brackets on back box
Wall thickness	independent or via adjustable brackets on panels with a thickness of 1-3 mm

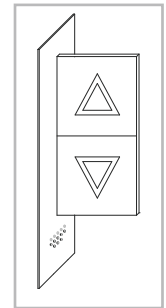

Flush mount in stone walls:

- without gong
- with gong

Width of the front plate:

- 100 mm

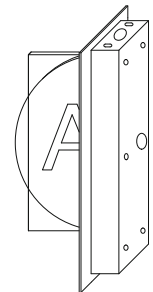
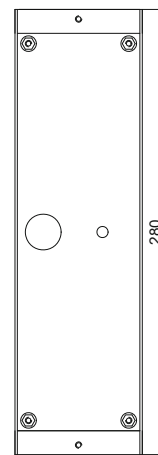
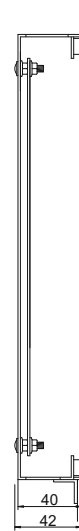
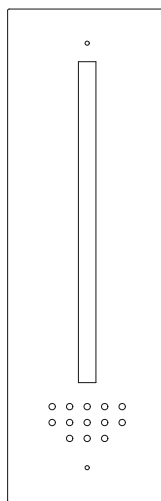
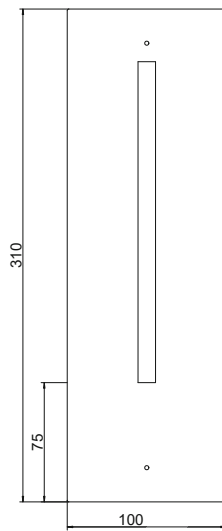

Cable openings at the top and lower short end and middle left

Flush mount in sheet metal panels:

- without gong
- with gong

Width of the front plate:

- 100 mm
- 90 mm , optional (only with panel mounting)

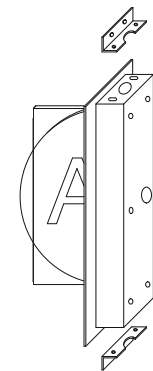
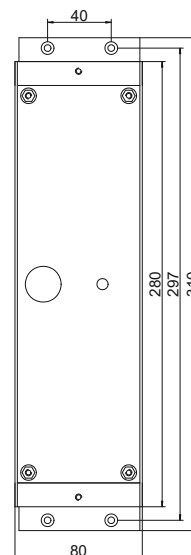
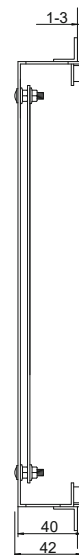
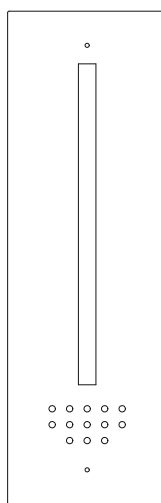
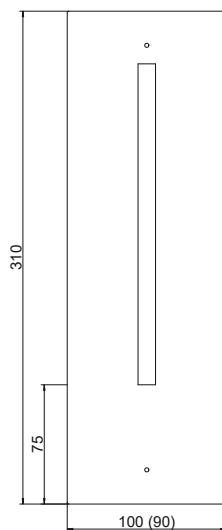









## General information and imprint

Figures, engineering drawings and dimensions in our catalogue are accurately made, but only approximate. Errors, improvements and technically reasonable construction changes are reserved. SCHAEFER GmbH assumes no liability for incidental or consequential damages in connection with the use of the catalogue. The catalogue, individual catalogue images (pictures) and extracts from the catalogue may be used without permission only for the distribution of the shown lift indicators. Otherwise all rights reserved.

### Publisher:

SCHAEFER GmbH  
Winterlinger Str. 4 | 72488 Sigmaringen  
Phone +49 7571 722-0 | Fax +49 7571 722-99  
[info@ws-schaefer.com](mailto:info@ws-schaefer.com) | [www.ws-schaefer.com](http://www.ws-schaefer.com)



Do you want more information?

We are always there for you:

Monday – Friday, 7:00 a.m – 18:00 p.m

**Feel free to contact us at +49 7571 722-0**

**SCHAEFER GmbH**

Winterlinger Str. 4 | 72488 Sigmaringen | Germany

Phone +49 7571 722-0 | Fax +49 7571 722-99

info@ws-schaefer.com | www.ws-schaefer.com

www.ws-schaefer.com



schaefer-products.com

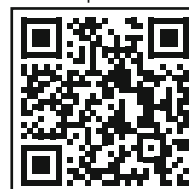

shop4lifts.com

